

Data sheet | Item number: 280-503/281-579

Component terminal block; double-deck; with end plate; with gas-filled surge arrester; for DIN-rail 35 x 15 and 35 x 7.5; 2.5 mm²; CAGE CLAMP®

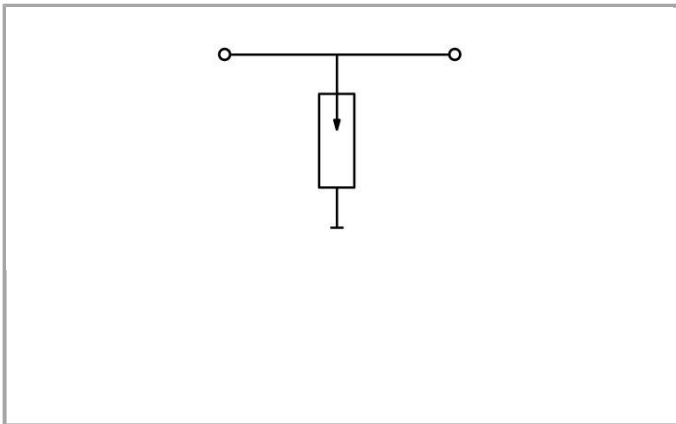

280-503/281-579

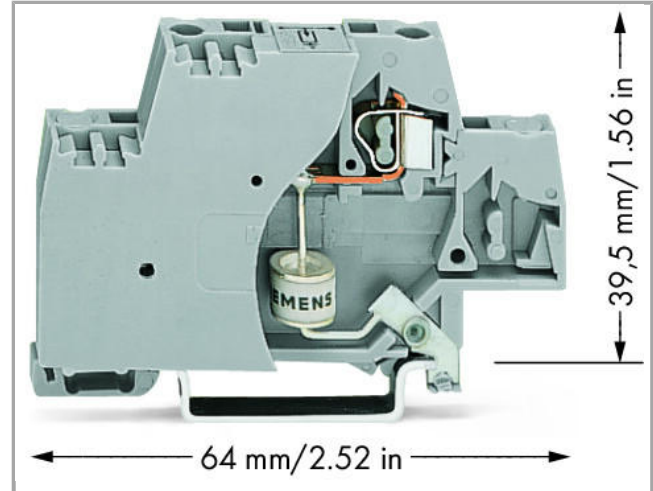
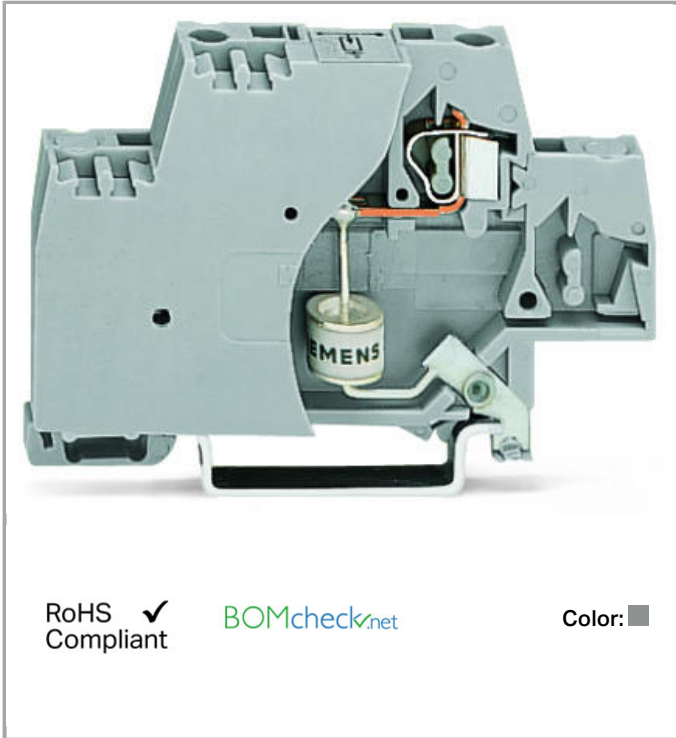

Item description

Short description:

Terminal blocks with surge suppression device and direct connection to the DIN-35 rail; these single-stage surge suppression devices are equipped either with 280 Series gas-filled surge arrester (coarse), varistor (medium) or suppressor diode (fine).

Features:

- Protect your system against overvoltage
-



- Slim, space-saving design
- Control operational costs by preventing expensive, unplanned downtime
- High operational reliability and system uptime

Data

Electrical data

Nominal operating voltage	AC/DC 24 V
Maximum continuous operating voltage	AC 70 V / DC 90 V
Rated continuous current	20 A
Nominal discharge current (8/20 µs) per line	5 kA
Voltage protection level (8/20 µs)	≤ AC 600 V
Response time line/line	≤
Capacitance	≤ 2 pF

Connection data

Connections (number)	2
Connection technology	CAGE CLAMP®
Solid conductor	0.08 ... 2.5 mm ² / 28 ... 14 AWG
Fine-stranded conductor	0.08 ... 2.5 mm ² / 28 ... 14 AWG
Strip length	8 ... 9 mm / 0.31 ... 0.35 inch

Geometrical Data

Width	10 mm / 0.394 inch
Height from upper-edge of DIN-35 rail	39.5 mm / 1.555 inch
Depth	64 mm / 2.52 inch

Mechanical data

Design	With end plate; with direct connection to DIN rail
Type of mounting	DIN-35 rail

Material Data

Color	gray
Fire load	0 MJ
Weight	13 g

Commercial data

Product Group	1 (Rail Mounted Terminal Blocks)
Country of origin	DE
GTIN	4045454194260

Customs Tariff No.

8536901000

Compatible products

tools

**Item no.: 210-720**

Operating tool with partially insulated shaft; Type 2, blade (3.5 x 0.5) mm

210-720

Insulation stop

**Item no.: 280-470**Insulation stop; 0.08 - 0.2 mm² "s" (0.14 mm² "f-st"); 5 pieces/strip

280-470

**Item no.: 280-471**Insulation stop; 0.25 - 0.5 mm²; 5 pieces/strip

280-471

**Item no.: 280-472**Insulation stop; 0.75 - 1 mm²; 5 pieces/strip

280-472

Jumper

**Item no.: 280-482**

Comb-style jumper bar; insulated; 2-way; IN = IN terminal block

280-482

**Item no.: 280-483**

Comb-style jumper bar; insulated; 3-way; IN = IN terminal block

280-483

**Item no.: 280-484**

Comb-style jumper bar; insulated; 4-way; IN = IN terminal block

280-484

**Item no.: 280-485**

Comb-style jumper bar; insulated; 5-way; IN = IN terminal block

280-485

**Item no.: 280-490**

Comb-style jumper bar; insulated; 10-way; IN = IN terminal block

280-490

**Item no.: 280-492**

Alternate comb-style jumper bar; insulated; 2-way; IN = IN terminal block

280-492

Marking accessories

**Item no.: 2009-145**

Mini-WSB Inline; for Smart Printer; on reel; stretchable 5 - 5.2 mm; plain; snap-on type

2009-145

**Item no.: 2009-145/000-002**

Mini-WSB Inline; for Smart Printer; on reel; stretchable 5 - 5.2 mm; plain; snap-on type

2009-145

/000-002

**Item no.: 2009-145/000-005**

Mini-WSB Inline; for Smart Printer; on reel; stretchable 5 - 5.2 mm; plain; snap-on type

2009-145















/000-005

**Item no.: 2009-145/000-006**

Mini-WSB Inline; for Smart Printer; on reel; stretchable 5 - 5.2 mm; plain; snap-on type

2009-145

/000-006

	Item no.: 2009-145/000-007 Mini-WSB Inline; for Smart Printer; on reel; stretchable 5 - 5.2 mm; plain; snap-on type	/000-007	2009-145
	Item no.: 2009-145/000-012 Mini-WSB Inline; for Smart Printer; on reel; stretchable 5 - 5.2 mm; plain; snap-on type	/000-012	2009-145
	Item no.: 2009-145/000-023 Mini-WSB Inline; for smartPRINTER; on reel; stretchable 5 - 5.2 mm; plain; snap-on type	/000-023	2009-145
	Item no.: 2009-145/000-024 Mini-WSB Inline; for Smart Printer; on reel; stretchable 5 - 5.2 mm; plain; snap-on type	/000-024	2009-145
	Item no.: 248-501 Miniature WSB Quick marking system; plain; Marker width 5 mm; 10 strips with 10 markers per card		248-501
	Item no.: 248-501/000-002 Mini-WSB marking card; as card; not stretchable; plain; snap-on type	/000-002	248-501
	Item no.: 248-501/000-005 Mini-WSB marking card; as card; not stretchable; plain; snap-on type	/000-005	248-501
	Item no.: 248-501/000-006 Mini-WSB marking card; as card; not stretchable; plain; snap-on type	/000-006	248-501
	Item no.: 248-501/000-007 Mini-WSB marking card; as card; not stretchable; plain; snap-on type	/000-007	248-501
	Item no.: 248-501/000-012 Mini-WSB marking card; as card; not stretchable; plain; snap-on type	/000-012	248-501
	Item no.: 248-501/000-017 Mini-WSB marking card; as card; not stretchable; plain; snap-on type	/000-017	248-501
	Item no.: 248-501/000-023 Mini-WSB marking card; as card; not stretchable; plain; snap-on type	/000-023	248-501
	Item no.: 248-501/000-024 Mini-WSB marking card; as card; not stretchable; plain; snap-on type	/000-024	248-501
End plate			
	Item no.: 280-340 End and intermediate plate; 2.5 mm thick		280-340
	Item no.: 280-341 End and intermediate plate; 2.5 mm thick		280-341



Downloads

Documentation

Additional Information

Disposal; Electrical and electronic equipment, Packaging	V 1.0.0	pdf 265.8 kB	Download
--	---------	-----------------	----------

CAD/CAE - Smart Data

CAD data

3D Download 280-503/281-579	URL	Download
-----------------------------	-----	----------

Subject to changes.
